

DETALHAMENTO - EXTERNO E INTERNO - PEÇAS

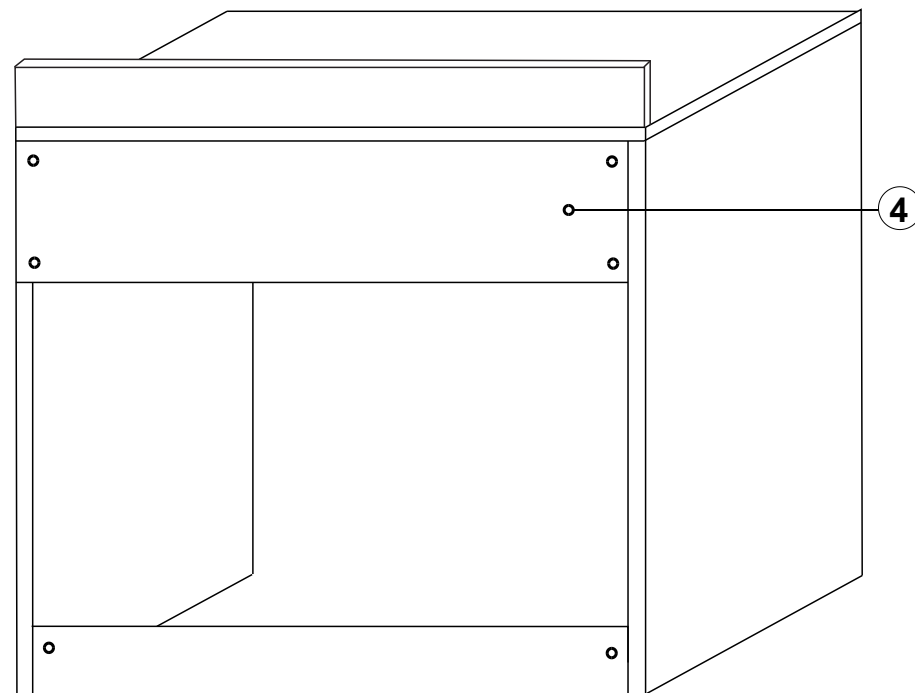
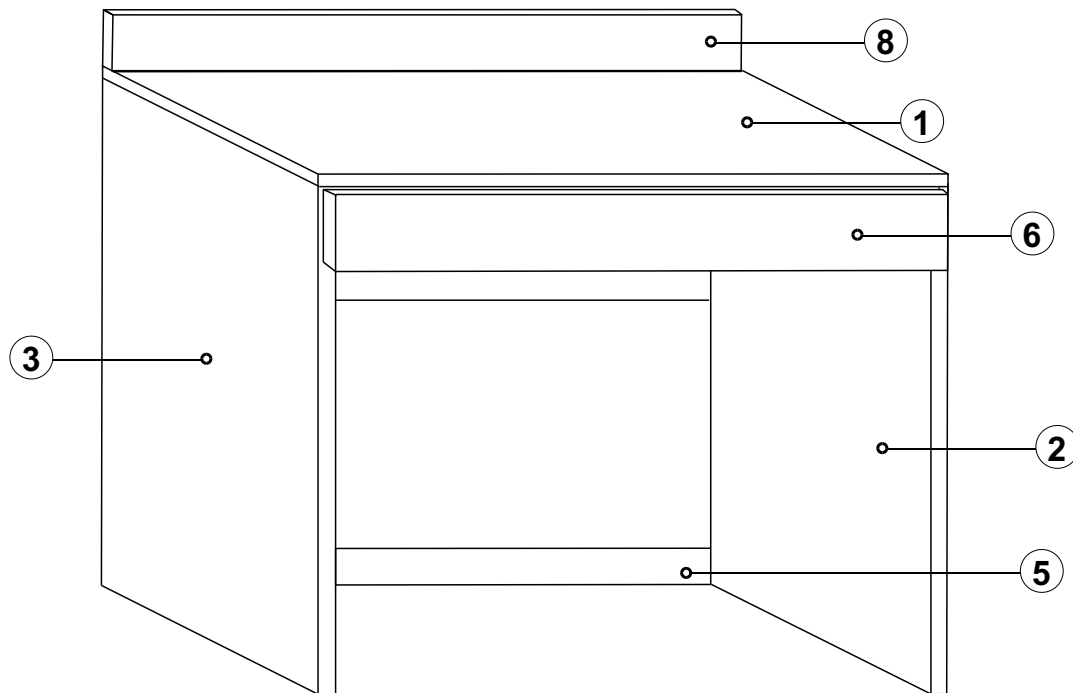

DIMENSÕES DO PRODUTO
Altura: 810mm
Largura: 715mm
Profundidade Total: 450mm

CORES
Código: 1 BRANCO
Código: 45 ONIX
Código: 52 CASTANHO
Código: 53 CHOCOLATE
Código: 68 CHOCOLATE/OFF WHITE
Código: 74 CASTANHO/ONIX

TABELA DE PEÇAS E CORES E INSUMOS											
Peça	Descrição	Medida (mm) Alt x Larg x Prof	Qtde	Código p/ Assistência Técnica	Tabela de Cores do Produto						Matéria Prima
					Branco	Cast/Onix	Onix	Choco/Off White	Castanho	Chocolate	
1	Tampo	716x450x15	1	6013	1	52	45	53	52	53	MDP
2	Lateral Direita	728x432x12	1	6014	1	52	45	53	52	53	MDP
3	Lateral Esquerda	728x432x12	1	6015	1	52	45	53	52	53	MDP
4	Frontão Traseiro	680x200x12	1	6017	1	52	45	53	52	53	MDP
5	Rodapé	680x80x12	1	6018	1	52	45	53	52	53	MDP
6	Frente Gaveta	704x100x12	1	6020	1	45	45	67	52	53	MDP
7	Fundo de Gaveta	654x300x2,5	1	6021	1	1	1	1	1	1	MDP
8	Moldura	714x70x15	1	6022	1	52	45	53	52	53	MDP
9	Lateral de Gaveta	295x80x12	2	168	1	1	1	1	1	1	MDP
10	Contra Frente	632x70x12	1	6019	1	1	1	1	1	1	MDP

CRIAÇÃO
24/01/2022

REVISÃO
EB
26/01/2022

Montagem
01 Pessoa



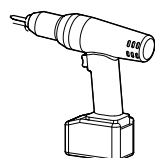





Ferramentas Necessárias (Não fornecidas)

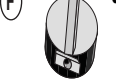

ATENÇÃO

PARA SOLICITAR PEÇAS DE REPOSIÇÃO, SEGUIR AS INSTRUÇÕES ABAIXO	. Representante; Encaminhar a assistência através do sistema TekSystem
1º - Informar o código da Pentadeira e cor, (Ex: 5998- 1)	. Lojista; Encaminhar por email - assistenciaticnica@quartadivisaomoveis.com.br
2º - Informar o código da peça, (Ex: 6013)	
3º - Informar o código de Cor da peça, (Ex: 1)	

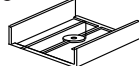
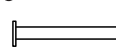
LISTA DE FERRAGENS E ACESSÓRIOS

(A) 14 Pçs  Cavilha Estriada 6x30mm	(B) 20 Pçs  Parafuso Cab.Chata Philips 3,5x12mm	(C) 06 Pçs  Parafuso Cab.Flangeada 4,0x50mm	(D) 03 Pçs  Parafuso Cab. Chata 4,0x35mm	(E) 04 Pçs  Parafuso Cab. Chata 6,0x8mm	(F) 06 Pçs  Porca Cilindrica 12mm	(G) 06 Pçs  Cantoneira de Metal 20x20mm	(H) 01 Pç  Sachet P.v.a 20g	(I) 04 Pçs  Sapata 20x13mm	(J) 15 Pçs  Prego 10x10mm	(K) 01 Pç  Corrediça Metalica 300mm	(L) 01 Pç  Adesivo - Logomarca Quarta Divisão Móveis
---	--	--	---	--	---	--	---	--	--	--	---

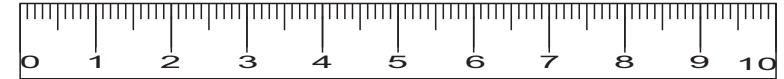

Use a régua para identificar os parafusos

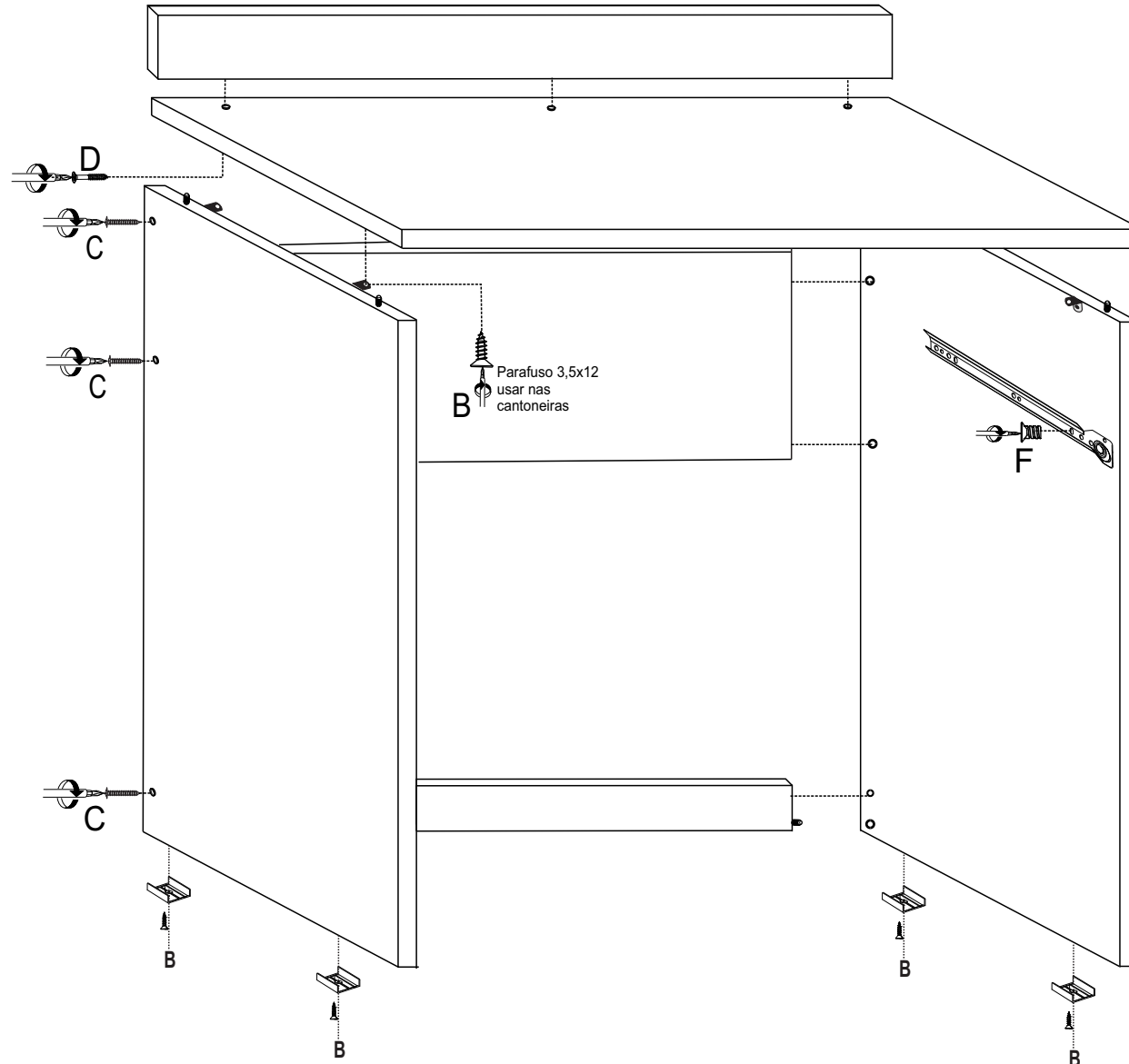

Passo 01 MONTAGEM DA GAVETA

Ao montar as gavetas, aplicar dois pontos de cola no canal da frente da gaveta e nas cavilhas que serão fixadas na frente da gaveta. Repetir este processo na outra gaveta.

- (G)** 04
- (E)** 08
- (A)** 08
- (H)** 01

Fixar a cantoneira 1mm recuado da borda da lateral de gaveta

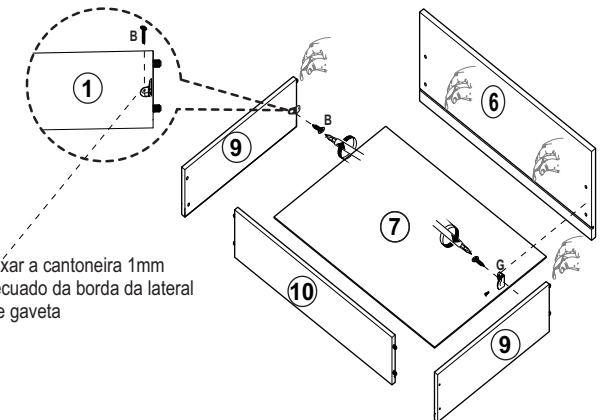

Passo 02 MONTAGEM DE FUNDO E CORREDIÇAS

Fixar as corrediças conforme ilustração abaixo. Repetir esse processo na outra gaveta.

- (J)** 20
- (B)** 08
- (K3)** 02
- (K2)** 02

